

Crystal Oscillators IC AN8956SSM

■ Overview

The AN8956SSM is a low-voltage operating IC for crystal oscillator. With a built-in stabilized power supply, oscillator circuit and output buffer, this IC facilitates construction of crystal oscillator circuitry.

■ Features

- Broad power supply voltage range : 2.3 V to 5.5 V
- SS Mini 5-pin package : 1.6mm × 1.6mm (incl. lead)

■ Applications

- Crystal oscillators for mobile communication equipment

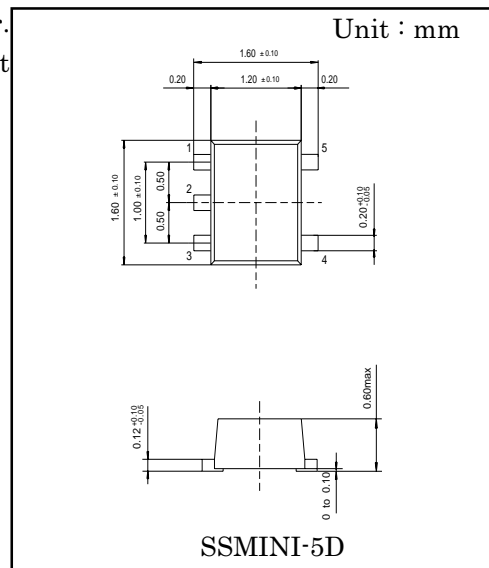

■ Block Diagram

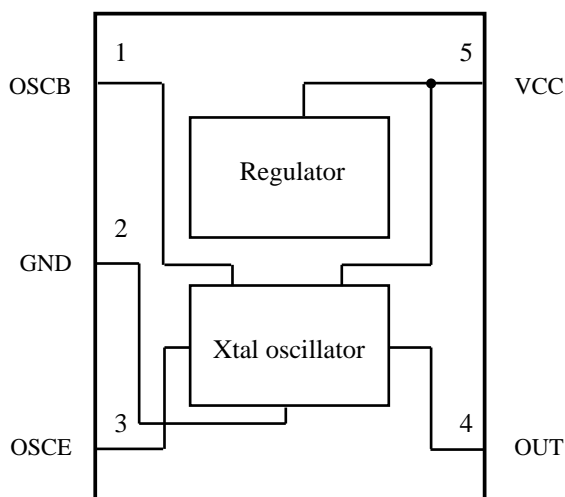

■ Pin Descriptions

Pin No.	Function
1	Oscillator input
2	GND
3	Oscillator feedback
4	Output
5	Power supply

! The products and specifications are subject to change without any notice. Please ask for the latest product standards to guarantee the satisfaction of your product requirements.

Semiconductor Company, Matsushita Electronics Corporation

■ Absolute Maximum Ratings

Parameters	Symbol	Rating	Item	Note
Storage temperature	T_{stg}	-55 to +125	°C	1
Operating ambient temperature	T_{opr}	-30 to +80	°C	1
Supply voltage	V_{CC}	6.5	V	
Supply current	I_{CC}	-	mA	
Power dissipation	P_D	54	mW	2

Note1) All items are at $T_a = 25^\circ\text{C}$, except for the operating ambient temperature and storage temperature parameters.

Note2) $T_a = 80^\circ\text{C}$

■ Recommended Operating Range

Supply voltage	V_{CC}	2.3 V to 5.5 V
----------------	----------	----------------

■ Electrical Characteristics ($T_a=25^\circ\text{C}\pm 2^\circ\text{C}$, $V_{CC}=2.7\text{V}$ unless otherwise specified)

Parameters	Symbol	Conditions	min	typ	max	Unit
Supply current	I_{CC}		1.18	1.42	1.66	mA
OSC B pin voltage	V_{OB}		1.12	1.34	1.56	V
OSC E pin voltage	V_{OE}		460	610	770	mV
OSC C pin current	I_{OC}		1.16	1.49	1.82	mA

■ Electrical Characteristics (Reference Data for Designing)

Parameters	Symbol	Conditions	min	typ	max	Unit
X tal oscillator frequency	FOSC	$f_{OSC}=26\text{ MHz}$	-50	-	+50	PPM
X tal oscillator amplitude	VPP	$f_{OSC}=26\text{ MHz}$	0.8	-	-	V_{P-P}
Oscillation circuit negative resistance	RN	$f_{OSC}=26\text{ MHz}$	100	-	-	Ω
Change in oscillator frequency with load	FOSCL	$R_L, C_L = \pm 10\%$	-0.2	-	+0.2	PPM
Change in oscillator frequency with supply voltage	FOSCV	$V_{CC} = \pm 0.1\text{ V}$	-0.2	-	+0.2	PPM
Output amplitude duty ratio	DUTY	Base on GND	40	-	60	%

* The above characteristics are reference values for designing and not guaranteed values.

■ Application Circuit

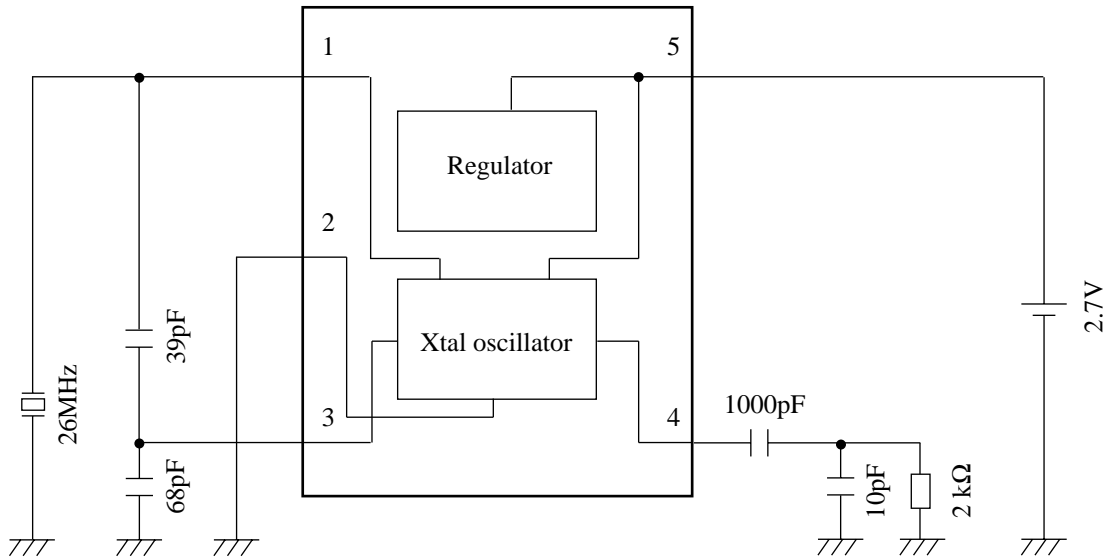

■ Package Power Dissipation

